

Individual mounting

sub-base
"plug-in"

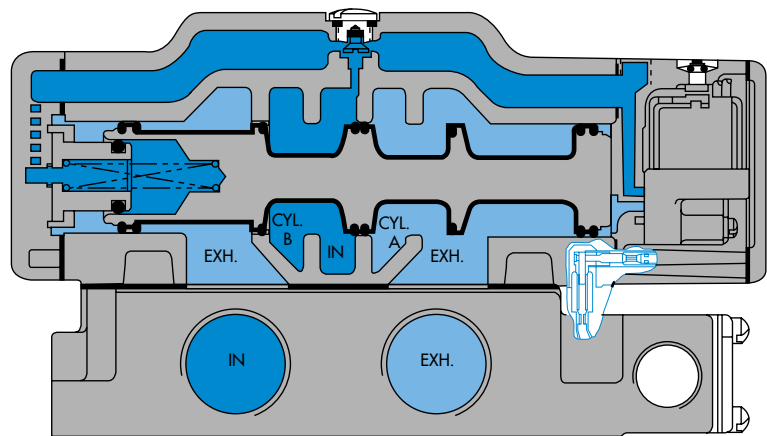

Function	Port size	Flow (Max)	Individual mounting
4/2 - 4/3	G3/4" - G1" - G1 1/4" - G1 1/2"	15900 NI/min	sub-base "plug-in"

OPERATIONAL BENEFITS

- Balanced spool, immune to variations of pressure.
- Short stroke with high flow.
- High shifting forces.
- Checked accumulator guarantees maximum pilot pressure.
- Powerful return force thanks to the combination of mechanical and air springs.
- Bonded spool with minimum friction, shifting in a glass-like finished bore.
- Wiping effect eliminates sticking.
- Pilot valve with balanced poppet, high flow, short and consistent response times.

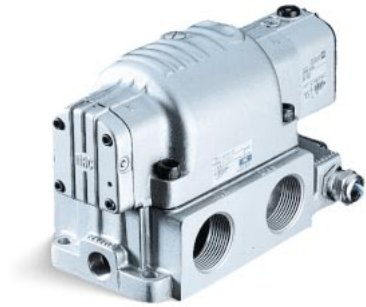

HOW TO ORDER

Reset

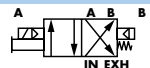
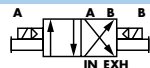
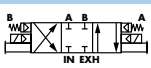
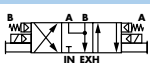
Port size	4/2 Single operator	4/2 Double operator	4/3 Closed centre	4/3 Open centre
				
Valve less base	1301G- XXY DA- XX	1303G- XXY DA- XX	1307G- XXY DA- XX	1308G- XXY DA- XX
Su base G 3/4"	1321G- XXY DA- XX	1323G- XXY DA- XX	1327G- XXY DA- XX	1328G- XXY DA- XX
Su base G 1"	1331G- XXY DA- XX	1333G- XXY DA- XX	1337G- XXY DA- XX	1338G- XXY DA- XX
Su base G1 1/4"	1351G- XXY DA- XX	1353G- XXY DA- XX	1357G- XXY DA- XX	1358G- XXY DA- XX
Su base G1 1/2"	1361G- XXY DA- XX	1363G- XXY DA- XX	1367G- XXY DA- XX	1368G- XXY DA- XX

SOLENOID OPERATOR >

XX Y DA- X X'

XX	Voltage	Y	Manual operator	X	Pilot air	X	Indicator light
11	110V~/50Hz	1	Non-locking	3	Internal	5	With light in base
12	220V~/50Hz	2	Locking	4	External		
22	24V~/50Hz						
87	24V=/17,1W						
59	24V=/2,5W						
61	24V=/8,5W						

**TECHNICAL
DATA**

Fluid :	Compressed air, vacuum, inert gases	
Pressure range :	Internal pilot : single operator and 3 positions : 1.8 to 10 bar	double operator : 0.7 to 10 bar
	External pilot : vacuum to 10 bar	
Pilot pressure :	Single operator and 3 positions : 1.8 to 10 bar	Double operator : 0.7 to 10 bar.
Lubrication :	Not required, if used select a medium aniline point lubricant (between 80°C and 100°C)	
Filtration :	40 µ	
Temperature range :	-18°C to +50°C	
Orifice :	35 mm	
Flow (at 6 bar, ΔP=1bar) :	G3/4" : 11500 NI/min (C _v 11.5) - G1" : 13700 NI/min (C _v 13.7) - G1 1/4" : 15400 NI/min (C _v 15.4) - G1 1/2" : 15900 NI/min (C _v 15.9)	
Leak rate :	100 cm ³ /min	
Coil :	Epoxy encapsulated - class A wires - 100% ED (specify mod 0449)	
Voltage range :	-15% to +10% of nominal voltage	
Protection :	IP 65	
Power :	- Inrush : 14.8 VA Holding : 10.9 VA = 1 to 17.1 W	
Response times :	24 V=/8.5 W Energize : 20 ms De-energize : 28ms	50Hz/6 W Energize : 17-23 ms De-energize :29-35 ms

Spare parts :

- Solenoid operator (power ≥ 4 W) : D1-XXBD. • Pressure seal between valve and base : 16083.
- Pilot valve : 150B-XXBD, including mounting screws 32180 and adaptor plate N-03001.
- Mounting screw valve to base (x4) : 32396.

Options :

- NPTF threads. • Lights in base.

DIMENSIONS

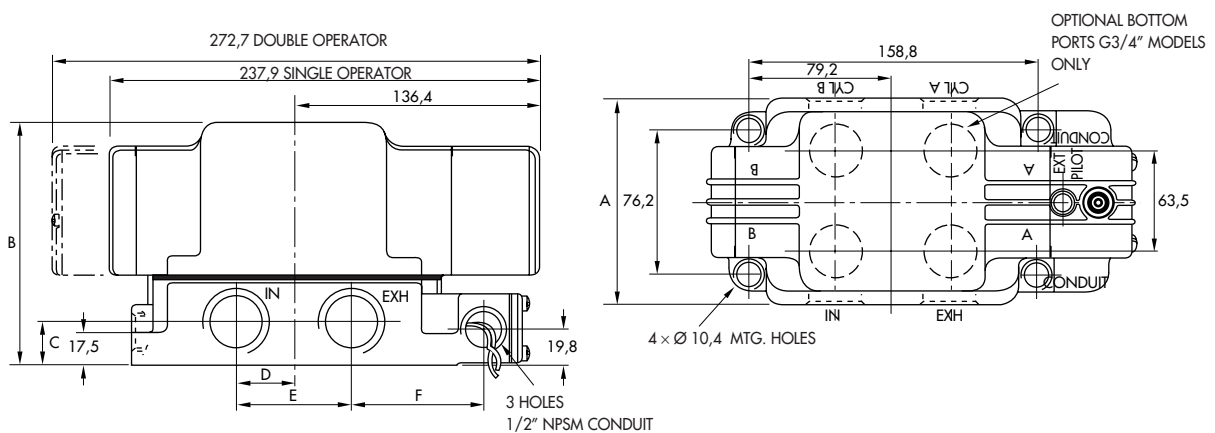

Port size	A	B	C	D	E	F
G3/4"	111,3	132,4	23,8	31,7	63,5	71,4
G1 1/4"	114,3	148,3	30,2	38,1	76,2	65,0
G1 1/2"				35,0	69,9	68,0

Codification table for voltages / Manual operator / Electrical connection / Wire length

VALVE CODE >

-XX Y ZZ (-VV)
1 2 3 4

OPTIONS AVAILABLE FOR	OPTIONS AVAILABLE FOR
<ul style="list-style-type: none"> - valves type 100 Series - pilot valves "CNOMO" 	<ul style="list-style-type: none"> - valves type 200 Series
<ul style="list-style-type: none"> - Pilot operated valves with pilots type 100 Series Series : 55 - 56 - 700 - 800 - 900 - 6200 - 6300 - 6500 - 6600 - 1300 - ISO 1 - ISO 2 - ISO 3. 	<ul style="list-style-type: none"> - pilot operated valves with pilots type 200 Series Series : 200 - 57 - 58 - 59.
<ul style="list-style-type: none"> - Pilot operated valves with pilots "CNOMO" Series : ISO1 - ISO2 - ISO3 	

1. VOLTAGE (type 100 Series)		1. VOLTAGE (type 200 Series)	
- XX Y ZZ	VOLTAGE	- XX Y ZZ	VOLTAGE
11	120 V~/60 Hz - 110 V~/50 Hz	11	120 V~/60 Hz - 110 V~/50 Hz - 24 V=
12	240 V~/60 Hz - 220 V~/50 Hz	12	240 V~/60 Hz - 220 V~/50 Hz
13	100 V~/60 Hz - 100 V~/50 Hz	13	100 V~/60 Hz - 100 V~/50 Hz
15	200 V~/60 Hz - 200 V~/50 Hz	14	200 V~/60 Hz - 200 V~/50 Hz
16	10 V~/60 Hz	20	6 V~/60 Hz
20	6 V~/60 Hz	21	12 V~/60 Hz
21	12 V~/50 Hz - 12 V~/60 Hz	22	24 V~/60 Hz - 24 V~/50 Hz
22	24 V~/60 Hz - 24 V~/50 Hz	23	32 V~/60 Hz - 32 V~/50 Hz
23	32 V~/60 Hz - 32 V~/50 Hz	24	48 V~/60 Hz - 42 V~/50 Hz
24	48 V~/60 Hz - 42 V~/50 Hz	25	240 V~/50 Hz
26	380 V~/50 Hz, 440 V~/50 Hz -440 V~/60 Hz, 480 V~/60 Hz-CLSF	26	480 V~/60 Hz - 440 V~/50 Hz
29	200 V~/60 Hz	27	127 V~/60 Hz
34	127 V~/50 Hz - 120 V~/50 Hz	28	415 V~/50 Hz
35	48 V~/50 Hz	29	200 V~/60 Hz
36	16 V~/60 Hz	30	380 V~/50 Hz
B1	24 V~/50 Hz	31	550 V~/60 Hz - 550 V~/50 Hz
50	24 V=/6 W	32	120 V~/60 Hz - 110 V~/50 Hz
51	24 V=/4 W	33	600 V~/60 Hz
54	12 V=/4 W	34	127 V~/50 Hz
55	12 V=/6 W	35	48 V~/50 Hz
57	12 V=/2,5 W	50	24 V=/6 W
59	24 V=/2,5 W	51	24 V=/4,5 W
60	12 V=/8,5 W	52	24 V=/2,5 W
61	24 V=/8,5 W	53	24 V=/1 W
64	6 V=/6 W	55	12 V=/6 W
65	32 V=/7 W	57	12 V=/2,5 W
66	48 V=/5,8 W	58	48 V=/2,5 W
67	64 V=/7,5 W	60	12 V=/9,5 W
68	120 V=/6,4 W	61	24 V=/8,5 W
69	220 V=/8,7 W - 250 V=/11,2 W CLSF	64	6 V=/8,5 W
75	90 V=/8,8 W CLSF	65	32 V=/10 W
76	100 V=/6,9 W CLSF	66	48 V=/11,5 W
84	125 V=/10,9 W CLSF	67	64 V=/10,5 W
87	24 V=/17,1 W CLSF	68	120 V=/12,3 W
88	12 V=/17,4 W CLSF	69	250 V=/9,2 W
89	36 V=/18,8 W CLSF	71	8 V=/8,2 W
90	28 V=/8,2 W	72	24 V=/12 W
91	6 V=/10,6 W CLSF	73	198 V=/10 W
92	190 V=/6,5 W	74	72 V=/11,3 W
94	3 V=/7 W	75	90 V=/11,3 W
95	38 V=/6,4 W	76	100 V=/9 W
A1	24 V=/1 W	77	220 V=/10 W - 230 V=/1,6 W
A2	12 V=/1 W	78	24 V=/24 W CLSF
A3	9 V=/1 W	80	55 V=/10,6 W CLSF
MOD. DD01 : Protection diode (DC)		82	179 V=/11,1 W
MOD. MOV1 : Protection varistor (AC)		83	15 V=/8,1 W
MOD. DD01 : max. 8,5 W		84	125 V=/10 W
MOD. MOV1 : max. 8,5 W		86	36 V=/11 W
		93	12 V=/24 W CLSF

2. MANUAL OPERATOR (Common options for 100 & 200 Series)

- XX Y ZZ	MANUAL OPERATOR
0	No operator
1	Non-locking recessed
2	Locking recessed
3	Non-locking extended
4	Locking extended

3. ELECTRICAL CONNECTION (type 100 Series)

- XX Y ZZ	ELECTRICAL CONNECTION
AA	Wiring box with 1/2" NPS conduit
BA	Flying leads
CA	1/2" NPS conduit
CC	1/2" NPS conduit
FA	Military type 2 PIN
GA	Military type 3 PIN
HA	AA with ground wire
JA*	Square connector
JB	Rectangular connector
JC*	Square connector with light
JD	Rectangular connector with light
JE	Square connector on top (ISO2, ISO3)
JF	Rectangular connector on top (ISO1, ISO2, ISO3)
JG	JE with light
JH	JF with light
JJ	Square connector, male only
JM	Rectangular connector, male only
MA	Electrical common conduit
MB	Electrical common conduit
NA	CA with ground wire
NC	CC with ground wire
RA	3/8" NPS conduit
AD	Wiring box 20 mm
AH	Wiring box PG 13,5 with ground wire
CD	20 mm conduit
CG	PG 11 conduit
HH	Wiring box PG 13,5 with ground wire
ND	20 mm conduit with ground wire
NG	PG11 conduit with ground wire
HD	20 mm wiring box with ground wire

3. ELECTRICAL CONNECTION (type 200 Series)

- XX Y ZZ	ELECTRICAL CONNECTION
AA	Wiring box with 1/2" NPS conduit
BA	Flying leads
CA	1/2" NPS conduit
CC	1/2" NPS conduit
EA	Explosion proof (200 Series)
EA	Explosion proof (57, 58 & 59 Series)
EE	Explosion proof (CENELEC)
EN	Explosion proof with ground wire
FA	Military type 2 PIN
GA	Military type 3 PIN
HA	AA with ground wire
JA*	Square connector
JC	Square connector with light
JJ	Square connector, male only
NA	CA with ground wire
NC	CC with ground wire
AD	Wiring box 20 mm
AK	PG 16 wiring box
CD	20 mm conduit
CK	PG 16 conduit
HD	20 mm wiring box with ground wire
HK	PG16 wiring box with ground wire
ND	20 mm conduit with ground wire
NK	PG16 wiring box with ground wire

* Not to be used with 100, 800 and 900 Series manifold mounting

4. WIRE LENGTH (Common options for 100 & 200 Series)

- XX Y ZZ (-VV)	WIRE LENGTH
AA	45 cm - 18"
AB	60 cm - 24"
AD	90 cm - 36"
AE	120 cm - 48"
AF	180 cm - 72"
AG	15 cm - 6"
AR	30 cm - 12"
AU	305 cm - 120"
BA	152 cm - 60"
BB	366 cm - 144"
Series 6000 : wire length, delivered with the base	
MOD L024	60 cm - 24"
MOD L036	91 cm - 36"
MOD L048	122 cm - 48"
MOD L060	152 cm - 60"
MOD L072	180 cm - 72"
MOD L120	305 cm - 120"